

Procedural Guidelines for Requesting Accelerated Patent Decisions under the Cooperation for facilitating Patent Grant of the Cambodia-related patent application between the Japan Patent Office and the Ministry of Industry & Handicraft of Cambodia

Applicants can request accelerated decisions on patents in Cambodia for patent applications that they have filed with the Department of Industrial Property (DIP) of the General Department of Industry of the Ministry of Industry & Handicraft (MIH) of Cambodia (hereinafter referred to as “the MIH patent applications”), which meet the following requirements based on their prescribed procedures, including related documents, under the Cooperation for facilitating Patent Grant of Cambodia-related patent application (hereinafter referred to as “the CPG”) that uses examination results of patent applications filed with the Japan Patent Office (JPO).

In requesting accelerated patent decisions based on the CPG, applicants must submit a request form to the MIH.

Whenever it is deemed necessary to either modify the CPG or terminate the CPG due to reasons such as the number of requests for accelerated patent decision based on the CPG exceeding a manageable level or other reasons, Ex Ante notice will be published.

1. Requirements for Making Requests

(a) There must be a Japanese patent application which has the same earliest date (whether this be a priority date or a filing date) (hereinafter referred to as the corresponding JPO patent application), which is the same as the MIH patent application on which CPG is requested.

The MIH patent application must be one of the following:

Case I: A patent application validly claiming priority under the Paris Convention based on the corresponding JPO patent application. (Examples are provided in Figures A, B, C, D, E, and F in Annex 1,); or

Case II: A patent application that serves as the basis for validly claiming priority under the Paris Convention of the corresponding JPO patent application (including a PCT patent application that entered the national phase) (Examples are provided in Figures G and H in Annex 1); or

Case III: A patent application that is based on the same patent application for claiming priority under the Paris Convention, as the corresponding JPO patent application (including a PCT patent application that entered the national phase.) (Examples are provided Figures I, J, K, J, L and M in Annex 1); or

Case IV: A PCT national phase application where both the corresponding JPO patent application and the MIH patent application are derived from a common PCT international application having

no priority claim (Example is provided in Figure N in Annex 1).

(b) The corresponding JPO patent application has been granted by the JPO

(c) All the claims in the MIH patent application requesting accelerated patent decision based on the CPG have been amended as required, so that the claims are the same as one or more claims in the corresponding JPO patent application granted by the JPO

Applicants are allowed to delete a part of the claims that were granted by the JPO (Such claims will be considered to be “the same”). However, when claims are deleted, it is necessary to state the claims on the “claims correspondence table” in a way that shows the correspondence between the claims granted by the JPO and the claims in the MIH patent application.

It should be noted that a claim in the MIH which introduces a new/different category of claims to those claims granted in the JPO is not considered as being the same. For example, when the JPO claims only contain claims to a process for manufacturing a product, then the claims in the MIH are not considered to be “the same”, if the MIH claims introduce product claims that are dependent on the corresponding process claims.

2. Documents to be Submitted

The following documents (a) to (c) must be submitted when requesting the CPG:

(a) A copy of the patent gazette in the corresponding JPO patent application and its certification issued by the JPO under the article 186 of the Japan Patent Act.

(b) A translation of Claims and Specification described in the patent gazette in English and in Khmer.

The translators into Khmer must provide a self-declaration on its translation documents. Applicants must submit a translation in Khmer within six months of the date on which the request was filed for the CPG.

(c) A claims Correspondence Table

Applicants must submit a claims correspondence table that shows the correspondence between all the claims in the MIH patent application and all the claims in the corresponding JPO patent application that are granted.

When the number for the claims granted by the JPO and the number for claims in the MIH patent application have become misaligned due to the deletion of claims, applicants are requested to state the claims in a way that clearly shows the correspondence between the claims granted by the JPO and the claims in the MIH patent application.



ព្រះរាជាណាចក្រកម្ពុជា

Kingdom of Cambodia

ជាតិ សាសនា ព្រះមហាក្សត្រ

Nation Religion King

ក្រសួងឧស្សាហកម្មនិង សិប្បកម្ម

Ministry of Industry and Handicraft

អគ្គនាយកដ្ឋានឧស្សាហកម្ម

General Department of Industry

នាយកដ្ឋានកម្មសិទ្ធិឧស្សាហកម្ម

Department of Industrial Property

ពាក្យសុំប្រកាសនីយតក្នុងកម្ពុជា

Request Form

កម្មវត្ថុ: សំណើសុំពន្លឿនលើការផ្តល់ប្រកាសនីយបត្រតក្កកម្មដ្ឋានកម្ពុជា Subject : Request for an accelerated decision under the CPG	សម្រាប់មន្ត្រីកាន់កាប់បញ្ជី For Registrar
	កាលបរិច្ឆេទទទួល : Receiving Date
	លេខរបស់សំណុំលិខិតស្នើសុំ : Application Number
	កាលបរិច្ឆេទសុំចុះបញ្ជី : Filing Date

លេខសំណុំសំណុំលិខិតស្នើសុំ/Patent Application number:

ការបរិច្ឆេទសុំចុះបញ្ជី/Date of filing :.....

ចំណងជើងនៃតក្កកម្ម/Title of invention :.....

អ្នកដាក់ពាក្យសុំ/ Applicant :

ពាក្យស្នើសុំពន្លឿនលើការផ្តល់ប្រកាសនីយបត្រតក្កកម្មដ្ឋានកម្ពុជា:.....

Corresponding patent application number

ត្រូវភ្ជាប់មកជាមួយនូវឯកសារដូចខាងក្រោម/Attached Documents:

ច្បាប់ចម្លងនៃពាក្យសុំប្រកាសនីយបត្រតក្កកម្មជប៉ុនដែលបានបោះពុម្ពផ្សាយក្នុងព្រឹត្តិបត្រប្រកាសនីយបត្រតក្កកម្ម និងមានការបញ្ជាក់ដោយអង្គការព្រឹត្តិបត្រប្រកាសនីយបត្រ តក្កកម្មជប៉ុន។

A copy of patent gazette in the corresponding JPO patent application, and its certification by the JPO

បកប្រែជាភាសាអង់គ្លេសនូវសេចក្តីអះអាង និងលក្ខណបច្ចេកទេសដែលពិពណ៌នានៅក្នុងព្រឹត្តិបត្រប្រកាសនីយបត្រតក្កកម្ម។

Translation of Claims and Specification described in the patent gazette in English

បកប្រែជាភាសាខ្មែរនូវសេចក្តីអះអាង និងលក្ខណបច្ចេកទេសដែលពិពណ៌នានៅក្នុងព្រឹត្តិបត្រប្រកាសនីយបត្រតក្កកម្ម។

Translation of Claims and Specification described in the patent gazette in Khmer (Translator must provide a self – declaration)

(ចំណាំ) អ្នកដាក់ពាក្យសុំត្រូវផ្តល់សេចក្តីបកប្រែក្នុងរយៈពេលប្រាំមួយខែ (៦) ចាប់ពីកាលបរិច្ឆេទនៃការស្នើសុំពន្លឿនលើការផ្តល់ប្រកាសនីយបត្រតក្កកម្ម (CPG) ។

(Note) Applicant may submit the translation within six months of date on which the request of the CPG was filed.

តារាងអំពីការផ្លាស់ប្តូរសេចក្តីអះអាង/Claims correspondence table

ហត្ថលេខា/ Signature

Claims correspondence table

The claim in the MIH	The granted claim in the JPO	Comments about the correspondence

Example

The claim in the MIH	The granted claim in the JPO	Comments about the correspondence
1	1	
2	2	
3	5	Claim 3 is the same as the granted claim 5 in the JPO. Granted Claims 3 and 4 in the JPO have been deleted.
4	6	Claim 4 is the same as the granted claim 6 in the JPO. Granted Claims 3 and 4 in the JPO have been deleted.

A

A case meeting requirement (a) (I)

- Paris route -

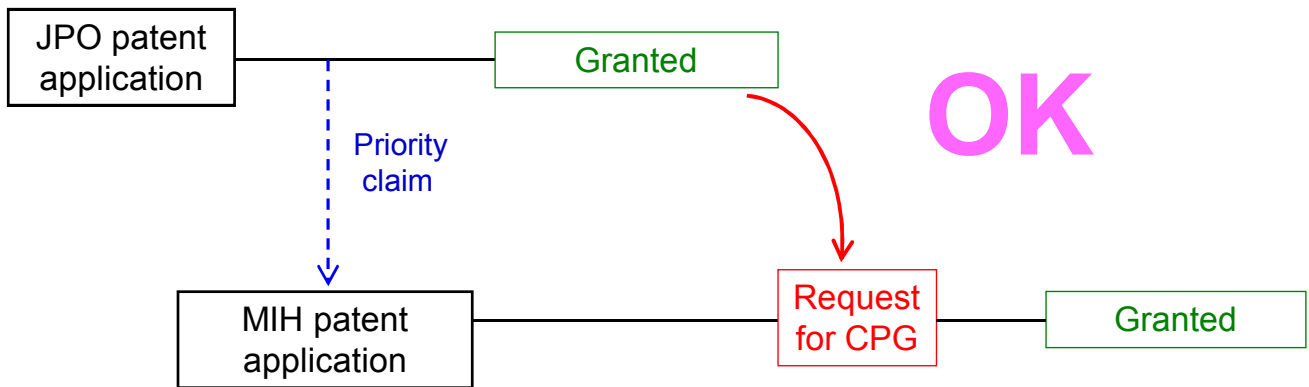

B

A case meeting requirement (a) (I)

- PCT route -

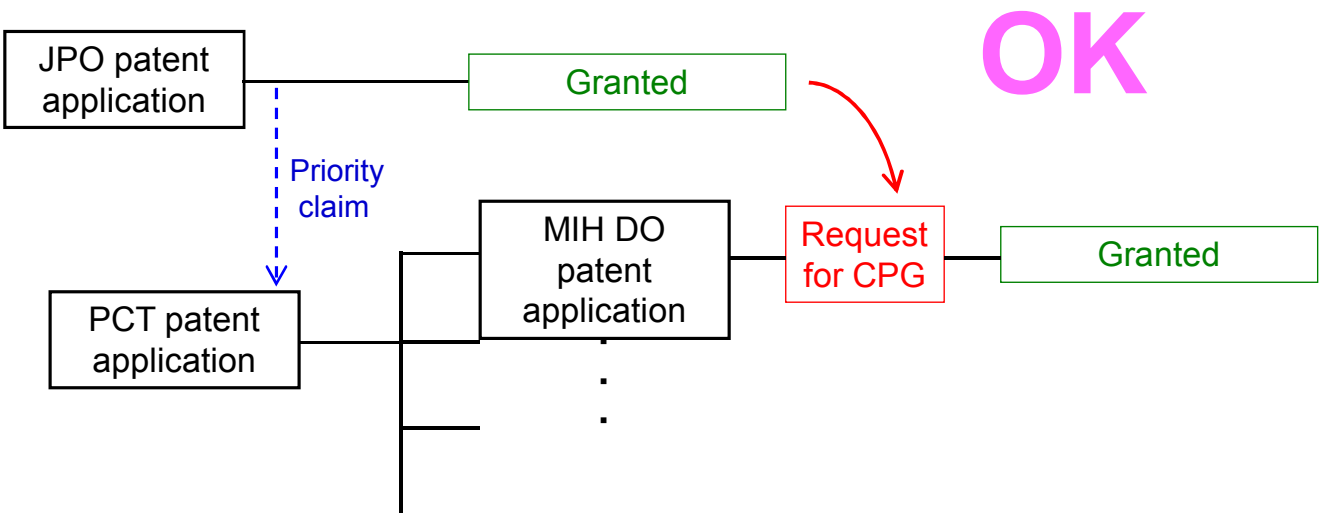

C

A case meeting requirement (a) (I)

- Paris route, Domestic priority -

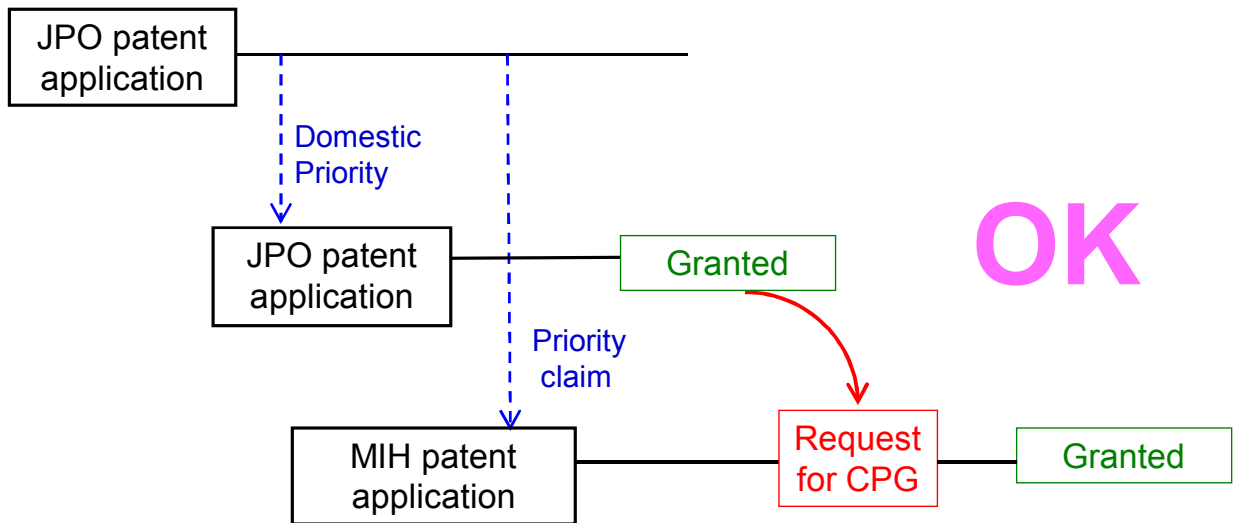

D

A case meeting requirement (a) (I)

- Paris route & Complex priority -

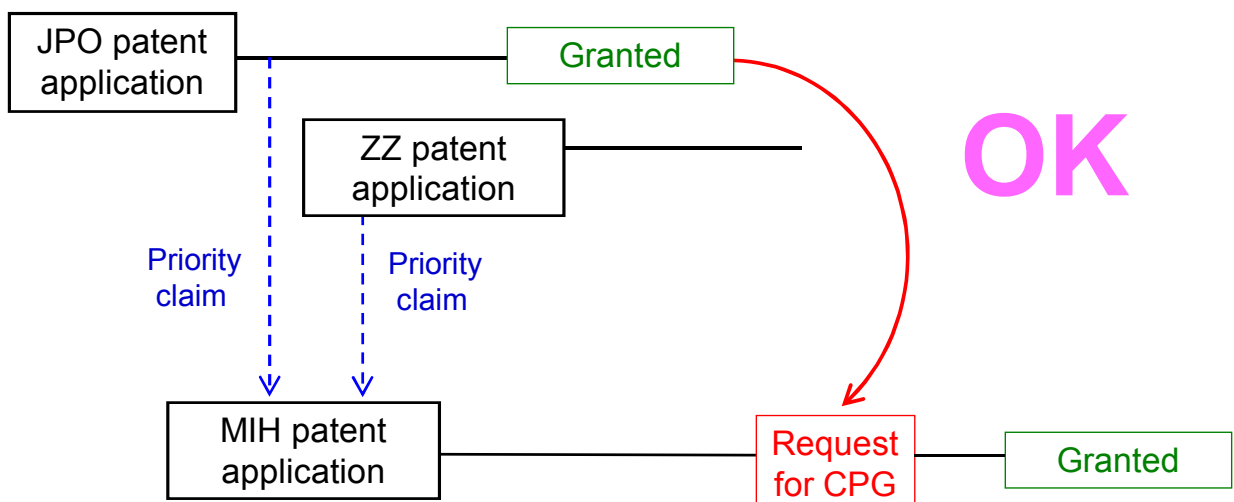

ZZ : any office

E A case meeting requirement (a) (I)

- Paris route & divisional patent application -

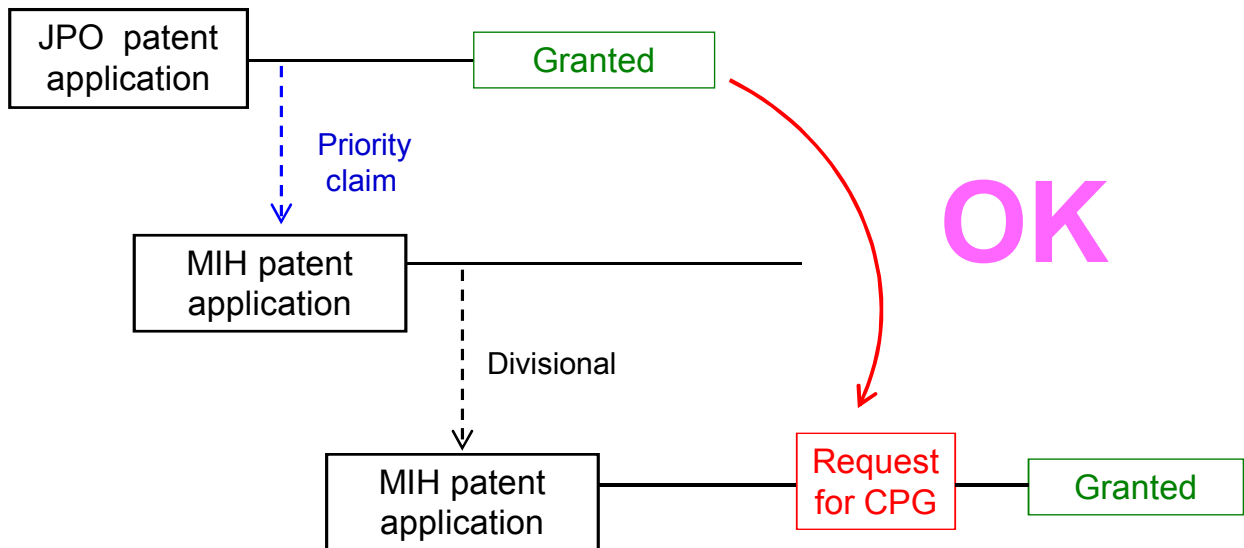

F A case meeting requirement (a) (I)

- PCT route -

New

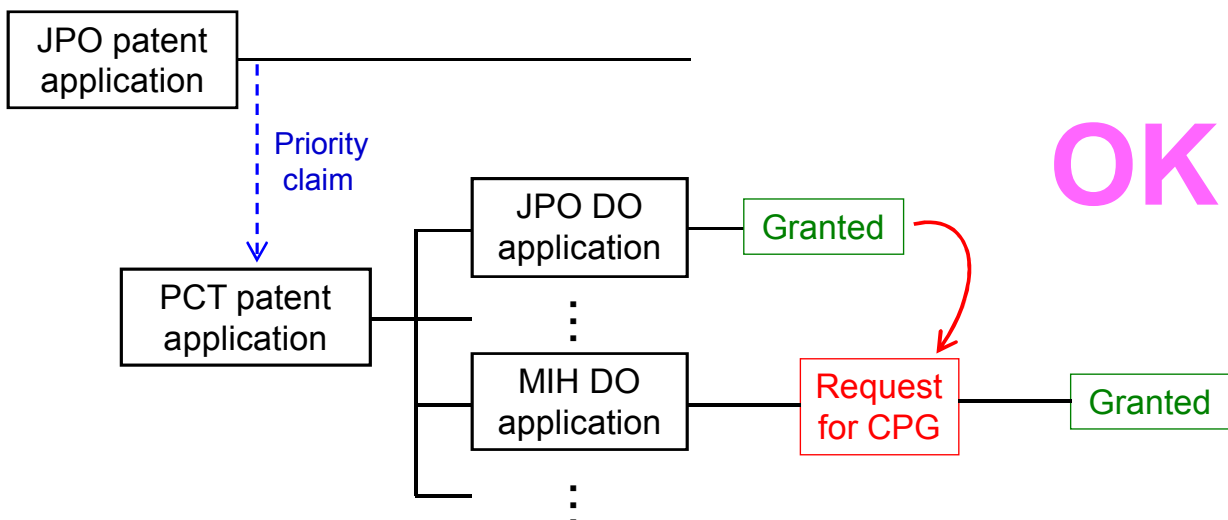

G

A case meeting requirement (a) (II)

- Paris route -

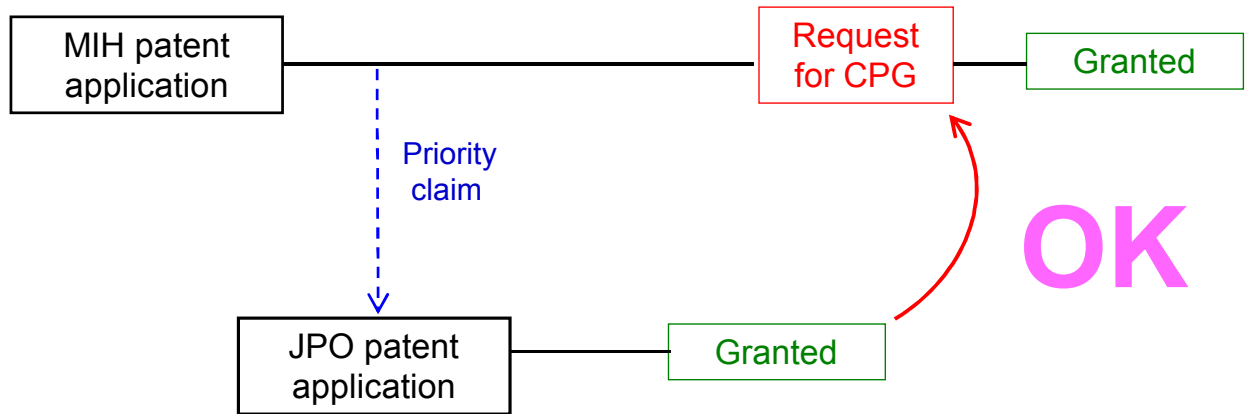

H

A case meeting requirement (a) (II)

- PCT route -

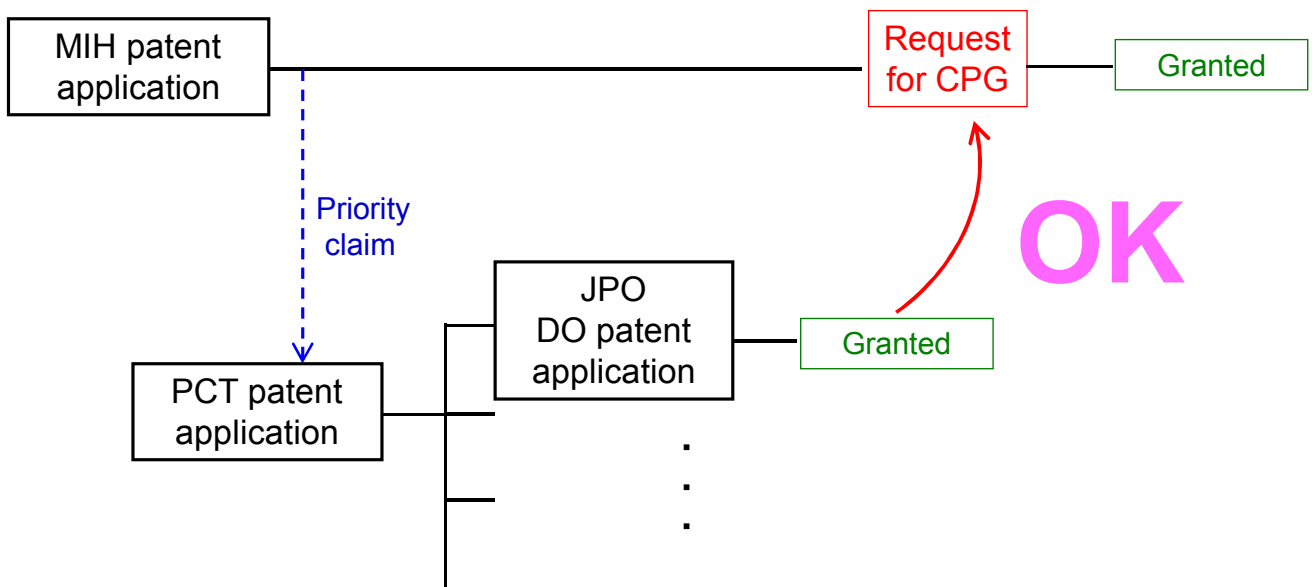

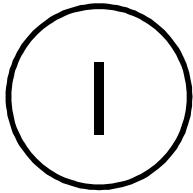

A case meeting requirement (a) (III)

- Paris route, but the first patent application is from the third country -

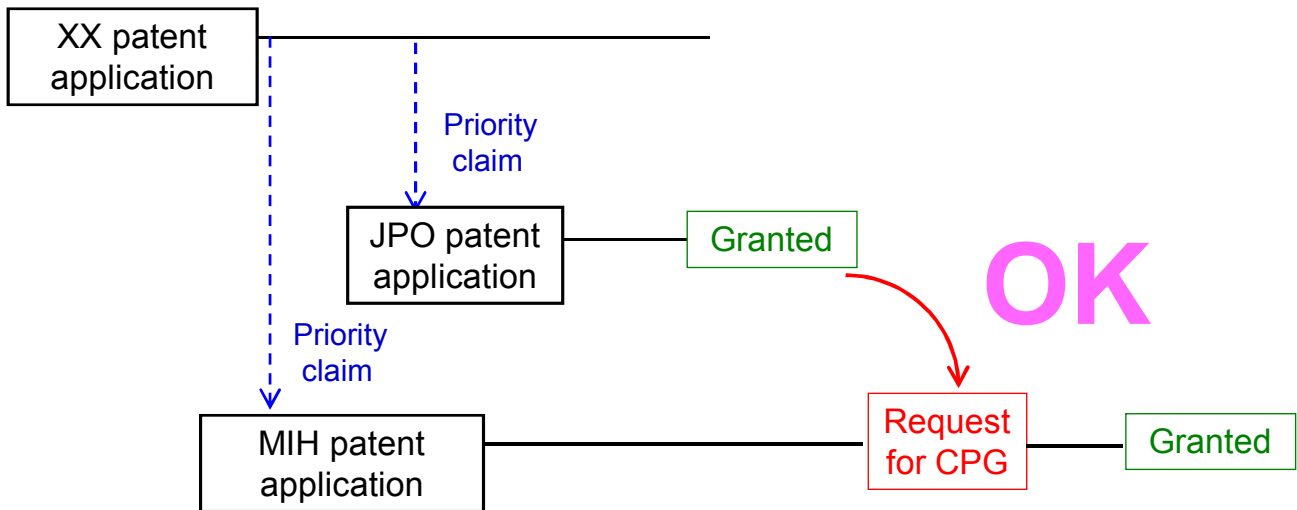

XX : the office other than the JPO

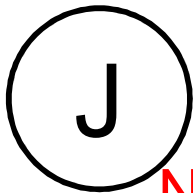

A case meeting requirement (a) (III)

- PCT route, but the first application is from the third country -

New

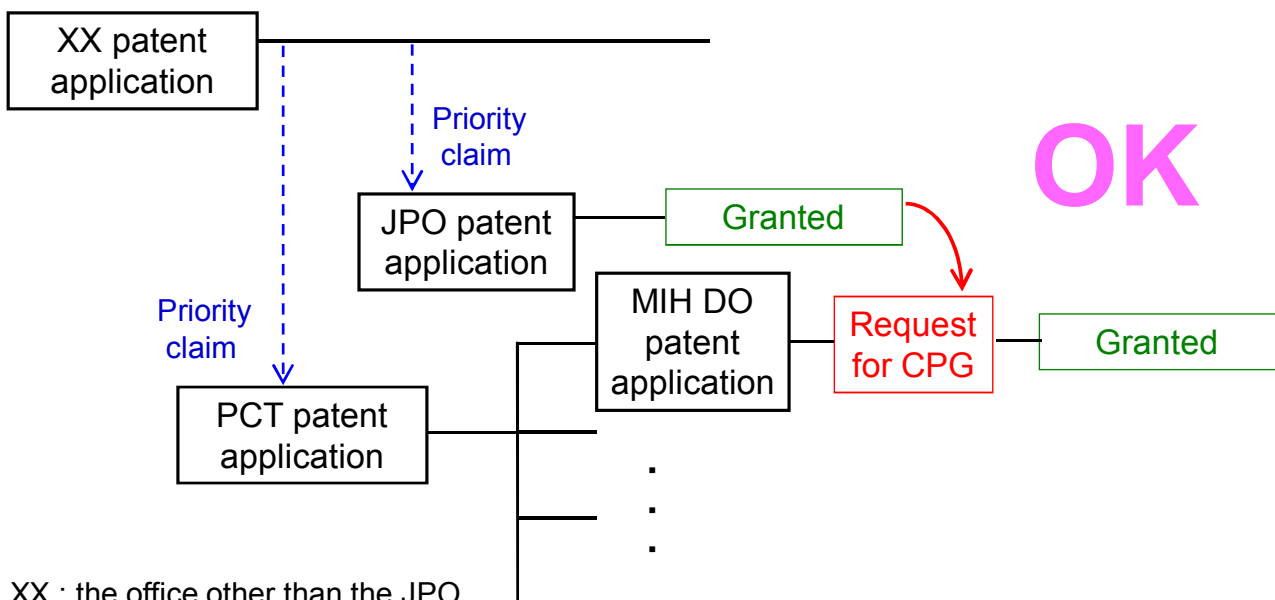

XX : the office other than the JPO

K A case meeting requirement (a) (III)

- Direct PCT & Paris route -

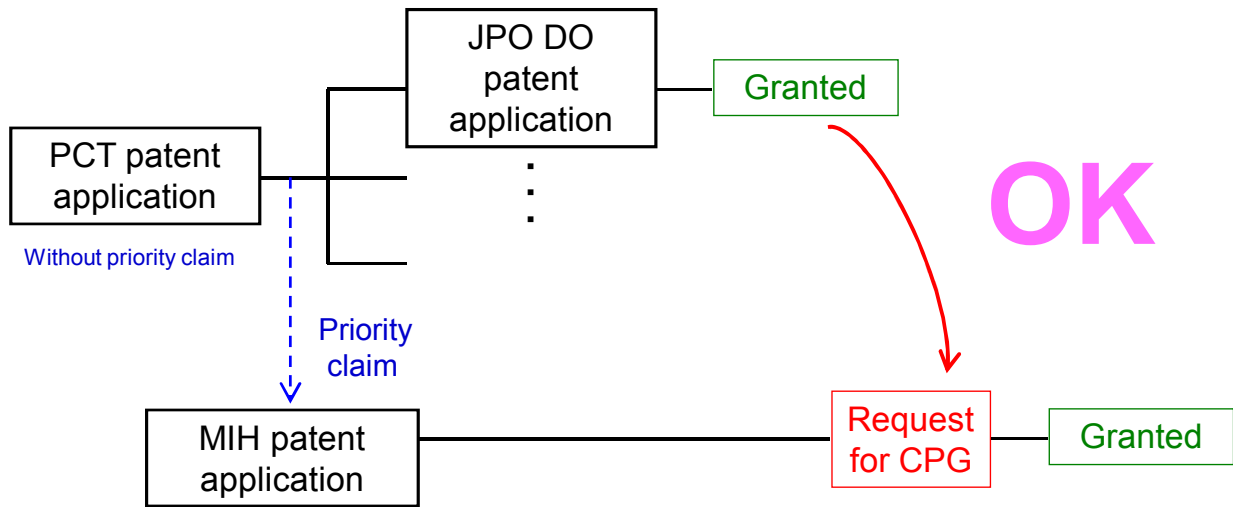

L A case meeting requirement (a) (III)

- Direct PCT & PCT route -

New

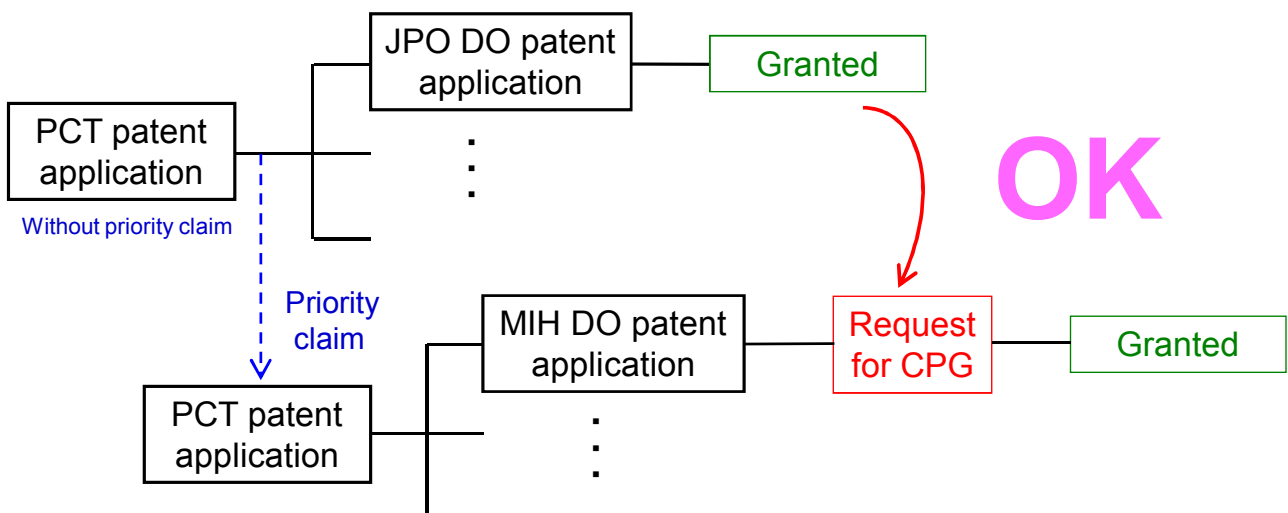

M A case meeting requirement (a) (III)

- Direct PCT & PCT route -

New

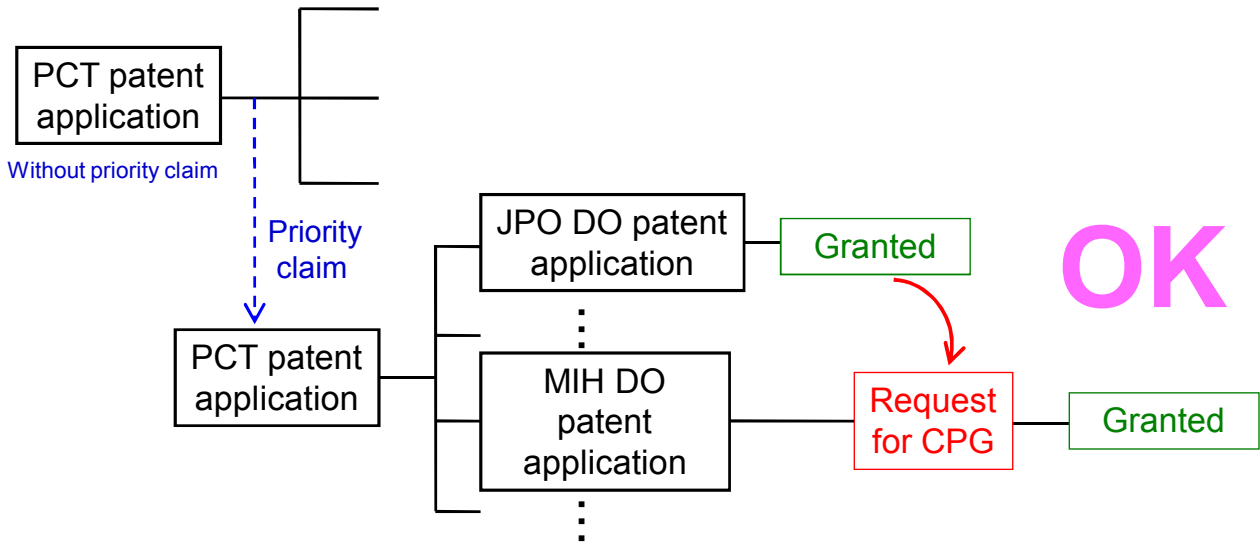

N A case meeting requirement (a) (IV)

- Direct PCT route -

New

