

Procedural Guidelines for Requesting Accelerated Patent Decision under the Cooperation for facilitating Patent Grant of the Laos-related patent application between the Department of Intellectual Property, Ministry of Science and Technology of Lao People's Democratic Republic and the Japan Patent Office

Applicants have Patent granted by the Japan Patent Office (JPO) can request accelerated decisions on patents in Laos with the Department of Intellectual Property (DIP), Ministry of Science and Technology of Lao People's Democratic Republic, which must meet the following requirements based on their prescribed provision and related documents, under the Cooperation for facilitating Patent Grant of Laos-related patent application that uses examination results of patent applications filed with JPO(hereinafter referred to as “the CPG”).

1. Requirements for Making Requests

(a) Both the DIP patent application on which the CPG is requested and the Japanese patent application (hereinafter referred to as “the corresponding JPO patent application”) forming the basis of the CPG request shall have the same earliest date with a priority date or a filing date.

The DIP patent application (including a PCT patent application that entered the national phase) must be one of the following:

Case I: A patent application validly claiming priority under the Paris Convention based on the corresponding JPO patent application. (Examples are provided in Figures A, B, C, D, E and F in Annex 1.); or

Case II: A patent application that serves as the basis for validly claiming priority under the Paris Convention of the corresponding JPO patent application (including a PCT patent application that entered the national phase) (Examples are provided in Figures G and H in Annex 1); or

Case III: A patent application that is based on the same patent application for claiming priority under the Paris Convention, as the corresponding JPO patent application (including a PCT patent application that entered the national phase.) (Examples are provided in Figures I, J, K, L and M in Annex 1); or

Case IV: A PCT national phase application where both the corresponding JPO patent application and the DIP patent application are derived from a common PCT international application having no priority claim (Example is provided in Figure N in Annex 1)

(b) The corresponding JPO patent application has been granted by the JPO

(c) All the claims in the DIP patent application requesting accelerated patent decision based on the CPG have been amended as required, so that the claims are the same as one or more claims in the corresponding JPO patent application granted by the JPO

2. Documents to be Submitted

The following documents (a) to (c) must be submitted when requesting the CPG:

(a) A request form.

(b) A copy of Certificate of patent by the JPO.

(c) A translation of Claims and Specification described in the patent gazette in English and in Lao (Applicants must submit a translation in Lao within three (3) months of the date on which the request was filed for the CPG).

(d) Amendment of the claims

In the case where the DIP patent application requesting accelerated patent decision based on the CPG does not meet item (c) of paragraph 1 (“Requirements for Making Requests”), applicants must submit the amendment of the claims to meet the requirement.

Note: Requirement(c)

Applicants are allowed to delete a part of the claims that were granted by the JPO (Such claims will be considered to be "the same"). In this case, it is expected that applicants submit a claims correspondence table that specifies the deleted claim(s) in the corresponding JPO patent application that has been granted and shows the correspondence between all the claims in the DIP patent application and all the claims in the corresponding JPO patent application that has been granted. It should be noted that a claim in the DIP patent application which introduces a new/different category of claims to those claims granted in the JPO patent application is not considered as being the same.



LAO PEOPLE'S DEMOCRATIC REPUBLIC
Peace Independence Democracy Unity Prosperity

Ministry Of Science and Technology
Department Of Intellectual Property

Nahaidyo Road, P.O. BOX: 2279;
Vientiane Capital, Lao PDR
Tel: +856 21 240784
Fax: +856 21 213472

Request form

Subject: Request for an accelerated patent decision under the CPG

Patent application number:

.....

Date of filing:

.....

Title of the Invention:
(in English)

.....

Title of the Invention:
(in Lao)

.....

Applicant(s):
(in English)

.....

Applicant(s):
(in Lao)

.....

Inventor(s):
(in English)

.....

Corresponding JPO patent
application number:

.....

Attached documents:

- Copy of Certificate of Patent by the JPO
- Translation of Claims and Specification described in the patent gazette in English
- Translation of Claims and Specification described in the Patent gazette in Lao
(Note) Applicant may submit this translation within three (3) months of the date on which the request for the CPG was filed.
- Amendment of the claims (where required)

A A case meeting requirement (a) (I)

- Paris route -

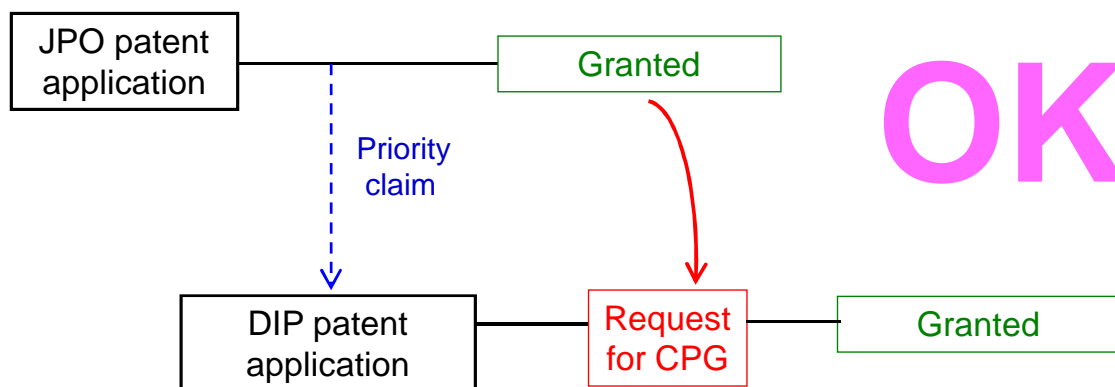

B A case meeting requirement (a) (I)

- PCT route -

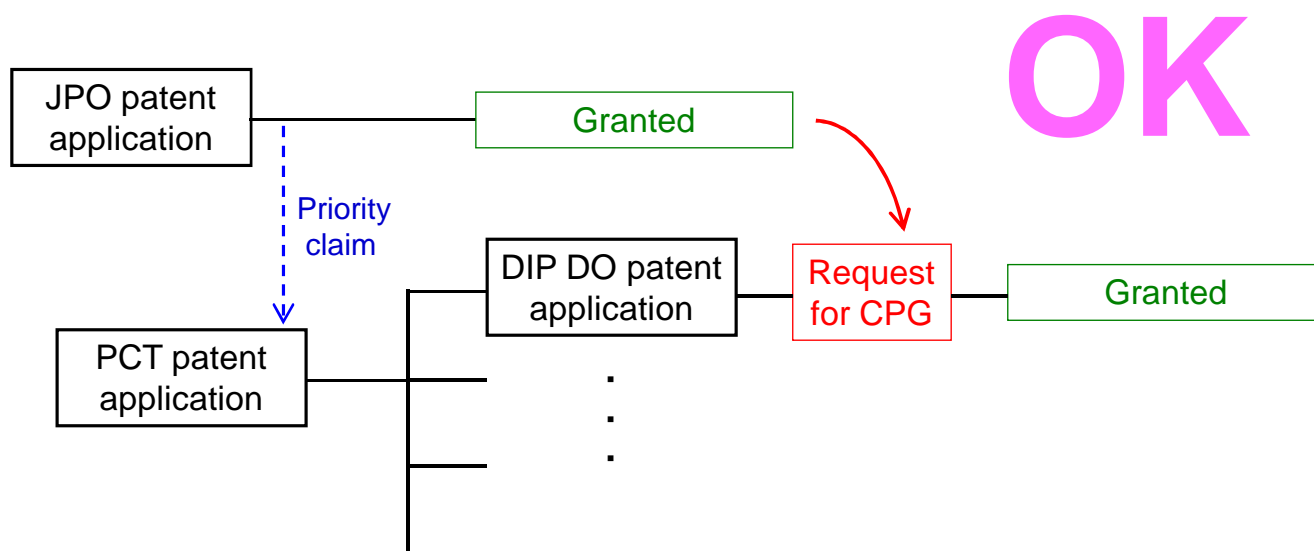

C

A case meeting requirement (a) (I)

- Paris route, Domestic priority -

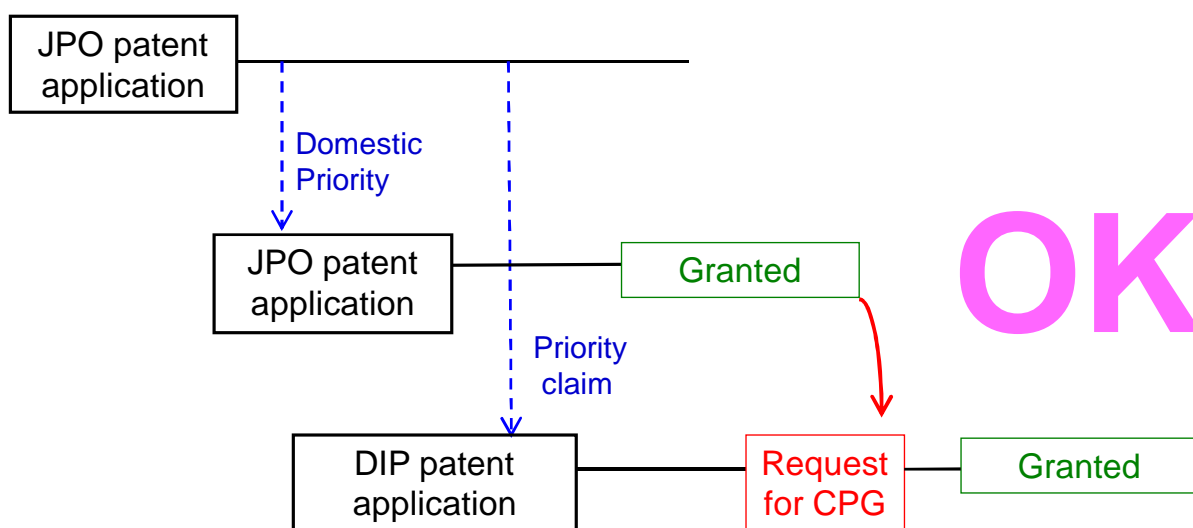

D

A case meeting requirement (a) (I)

- Paris route & Complex priority -

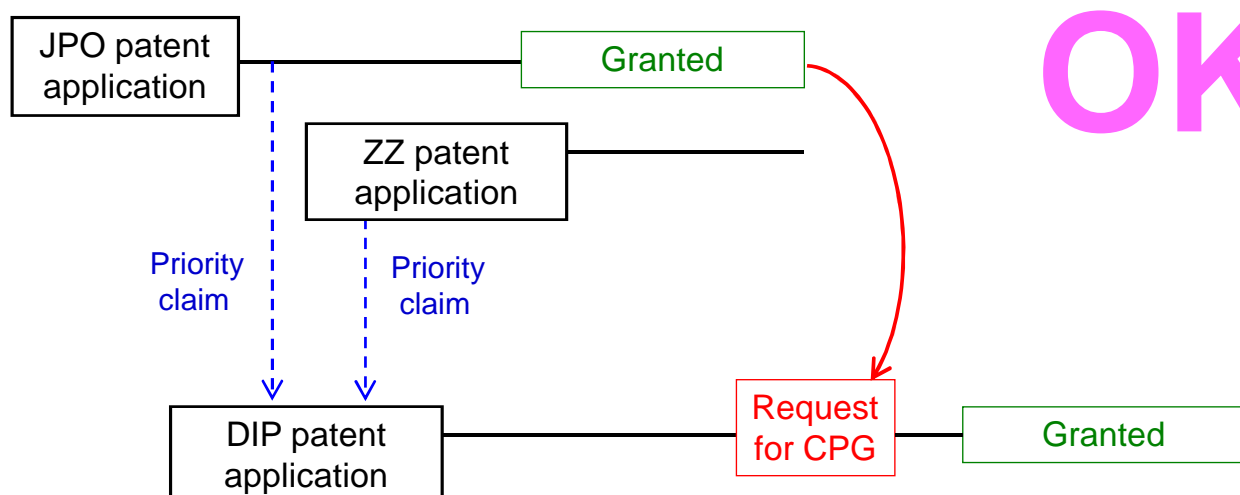

ZZ : any office

E A case meeting requirement (a) (I)

- Paris route & divisional patent application -

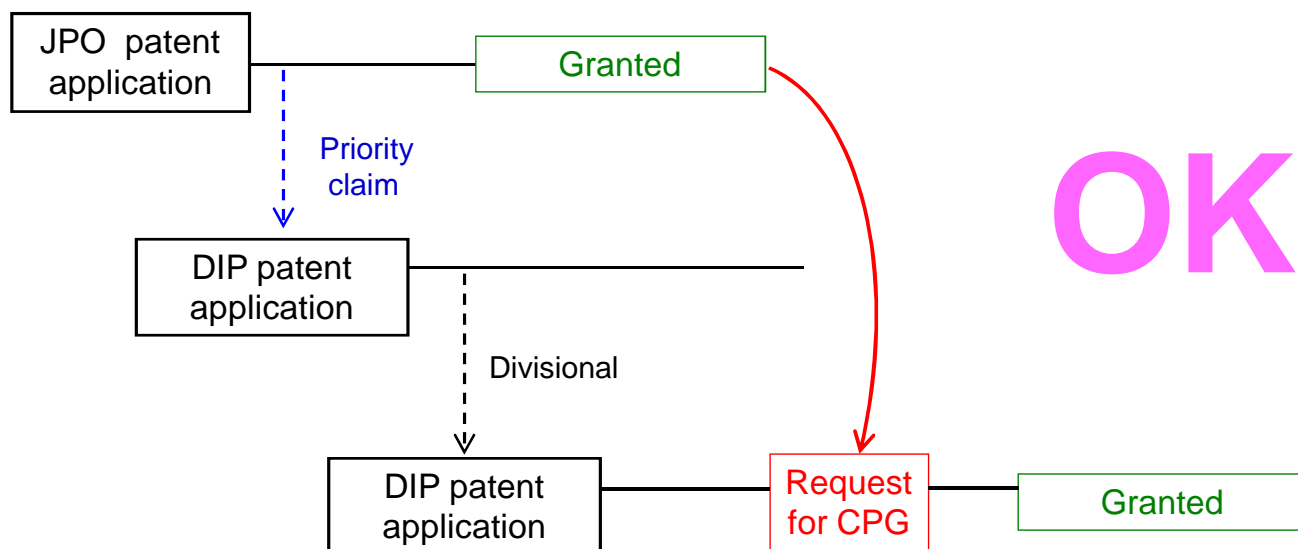

F A case meeting requirement (a) (I)

- PCT route -

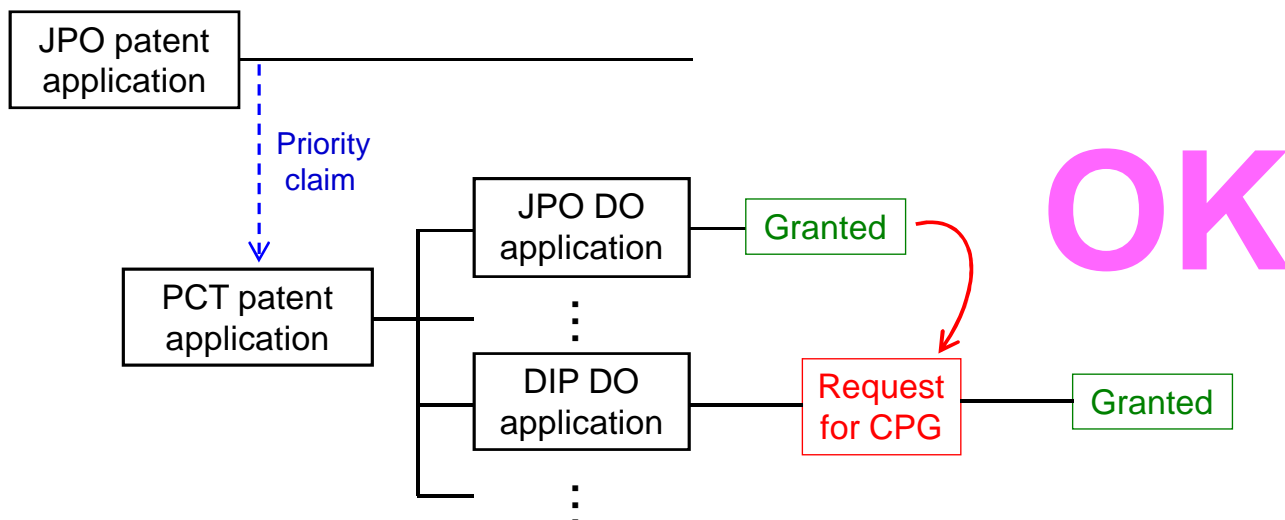

G

A case meeting requirement (a) (II)

- Paris route -

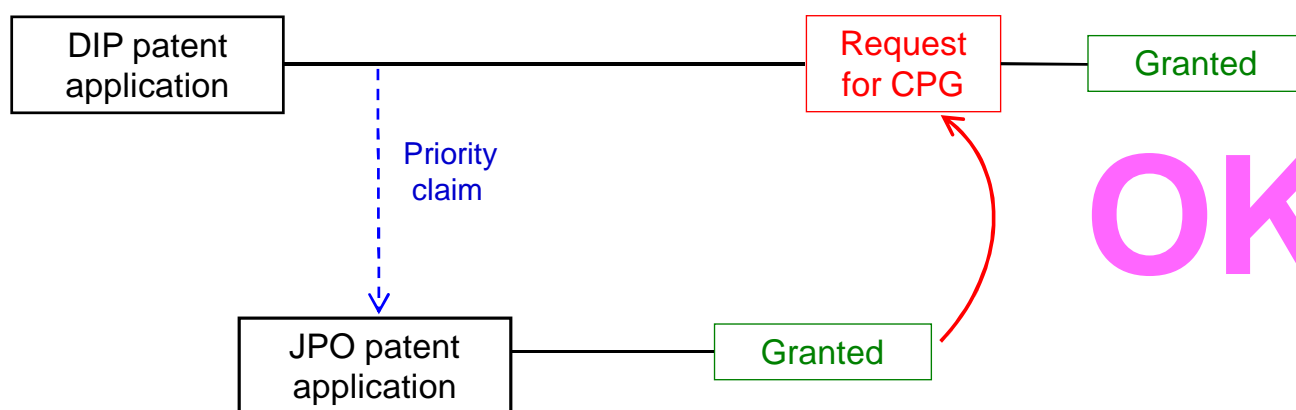
**OK****H**

A case meeting requirement (a) (II)

- PCT route -

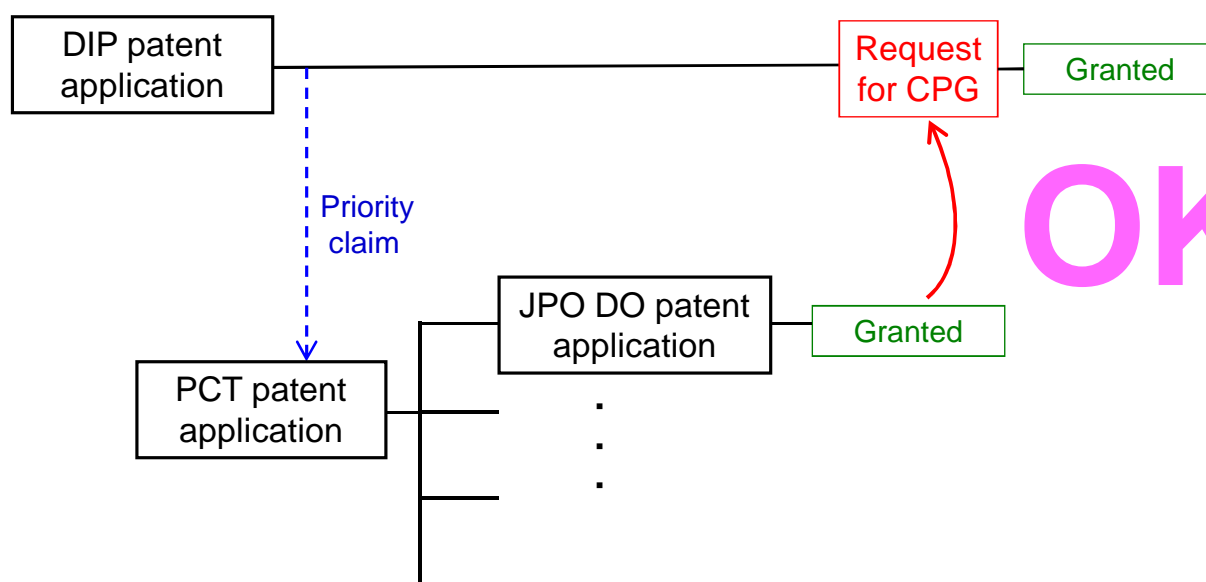
**OK**

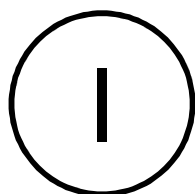

A case meeting requirement (a) (III)

- Paris route, but the first patent application is from the third country -

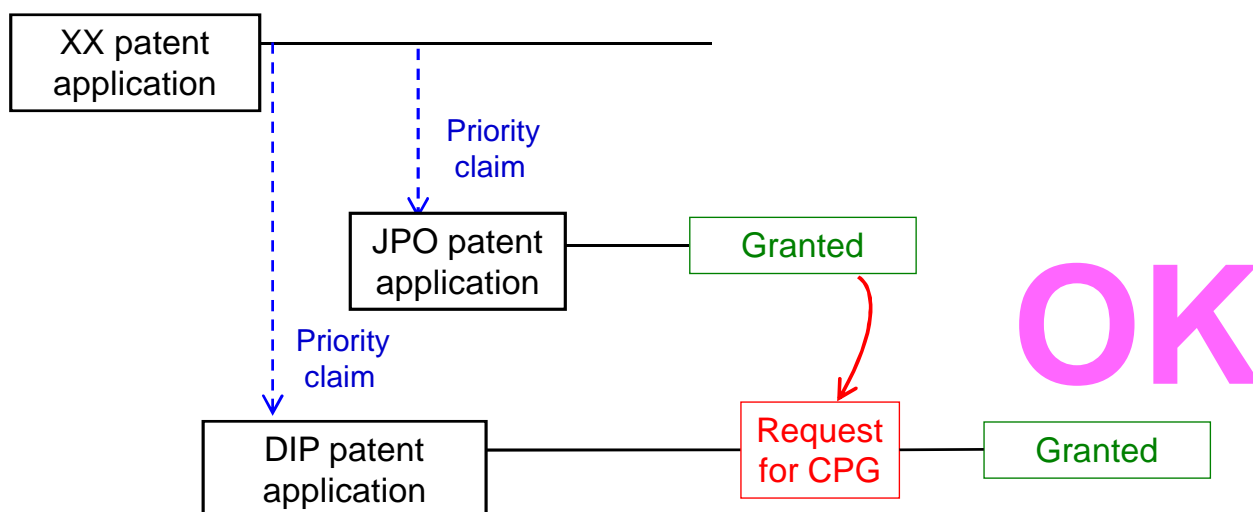

XX : the office other than the JPO

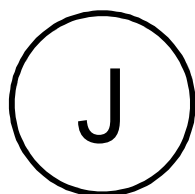

A case meeting requirement (a) (III)

- PCT route, but the first application is from the third country -

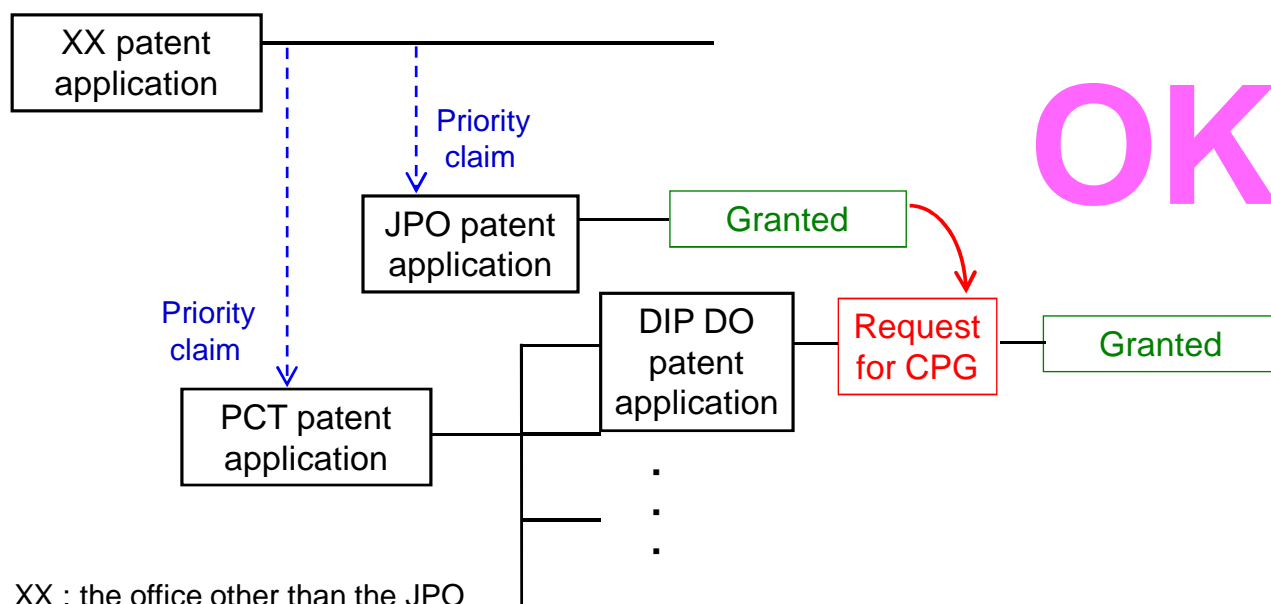

XX : the office other than the JPO

K A case meeting requirement (a) (III)

- Direct PCT & Paris route -

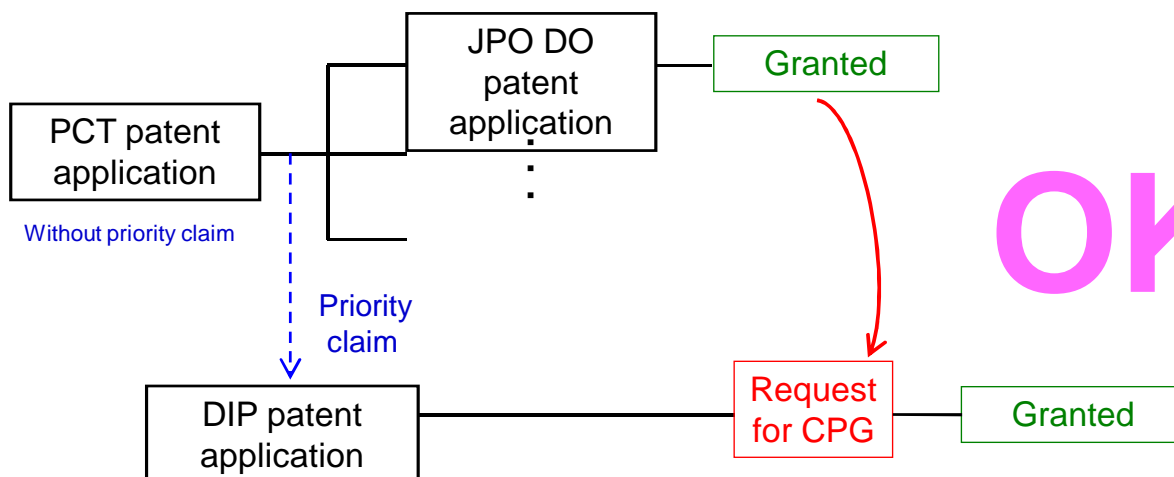

L A case meeting requirement (a) (III)

- Direct PCT & PCT route -

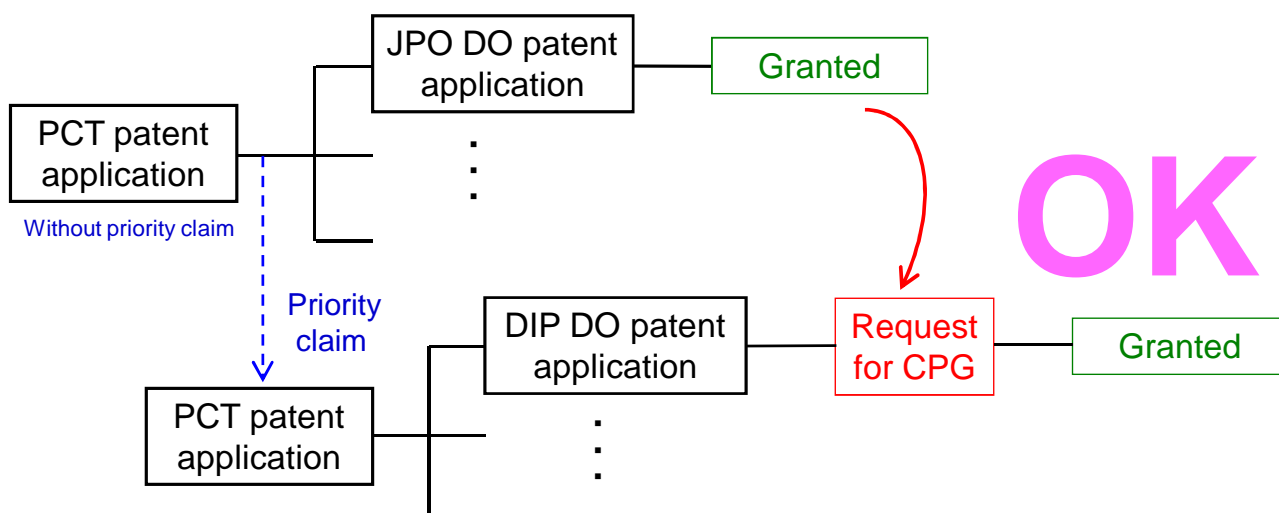

M A case meeting requirement (a) (III)

- Direct PCT & PCT route -

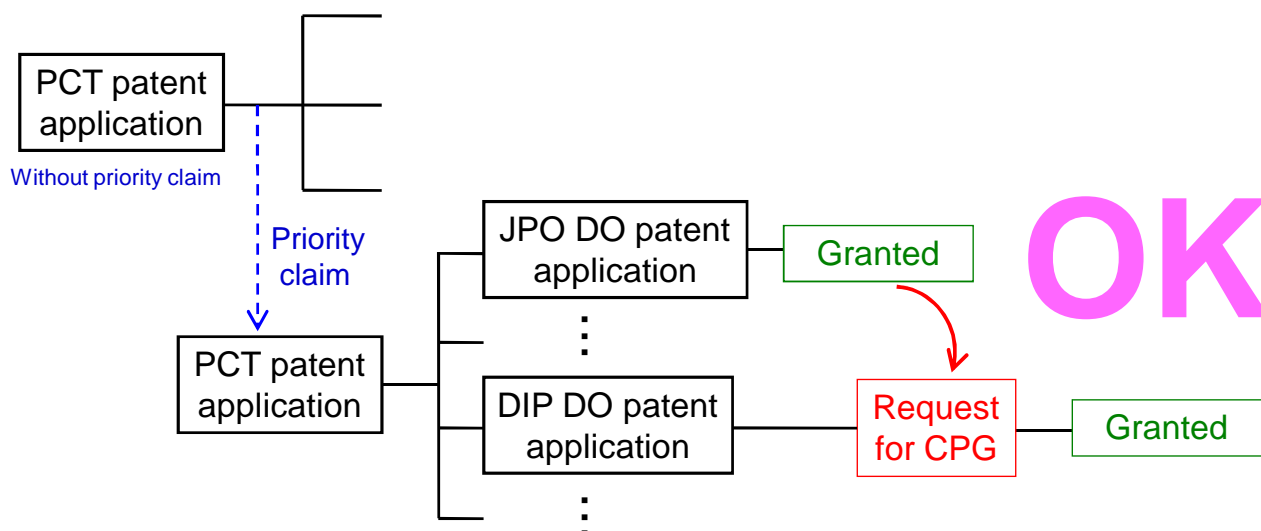

N A case meeting requirement (a) (IV)

- Direct PCT route -

